

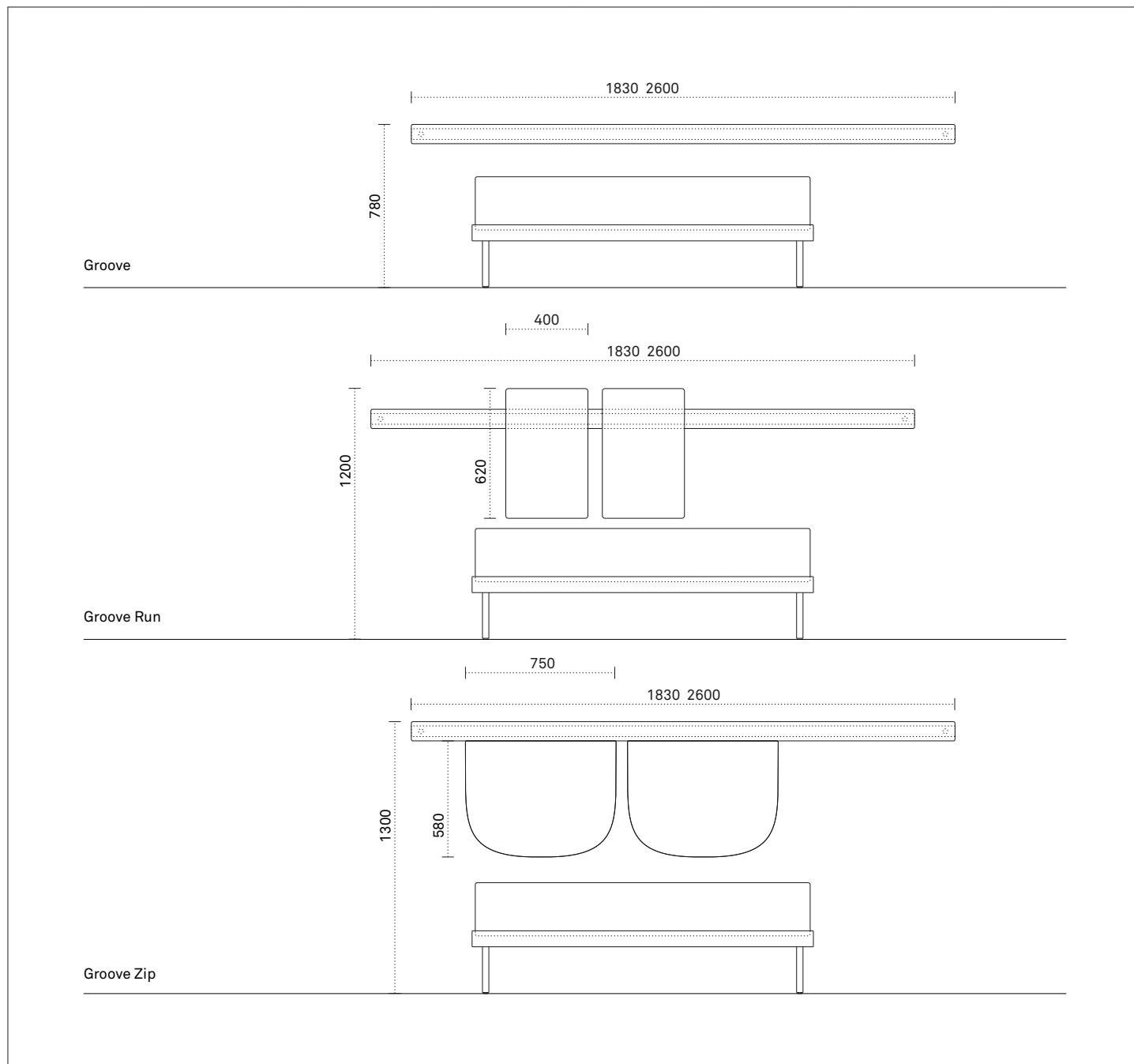

La barra Groove si rinnova in estetica e funzionalità. Una cerniera Zip scorre sulla corsia inferiore e aggancia due morbidi cuscini alla barra. Potrai toglierli, rimetterli e spostarli per dare a loro la posizione che desideri. Ancora più comodi, ancora più ergonomici: l'imbottitura generosa dei cuscini Zip, combinata alla rinnovata forma a mezzaluna, offre il giusto comfort e supporto alla tua schiena.

Dettagli tecnici



Dimensioni espresse in millimetri. L'azienda si riserva il diritto di apportare modifiche ai modelli senza preavviso. Le informazioni qui riportate sono basate sugli ultimi dati pubblicati su catalogo e listino.

Sartorialità



Tanti moduli, un'infinità di composizioni: è il risultato di una produzione organizzata in ottica 4.0, in cui ogni dettaglio è personalizzabile. Una soluzione su misura che veste la tua casa come un abito sartoriale. Centimetro dopo centimetro.

Componibilità



Cambiando l'ordine dei fattori il risultato cambia. La grande flessibilità del Sistema si misura sui moduli: accostandoli in modo diverso sulla parete e abbinando le finiture si ottengono risultati sempre su misura.

Illuminazione



Funzionale quando illumina l'interno dei moduli per vederne con chiarezza l'interno. Scenografica quando scandisce le composizioni e si fa luce d'atmosfera, discreta, incastonata nelle schiene o nei fianchi. Molto più di un accessorio.

Dettagli tecnici

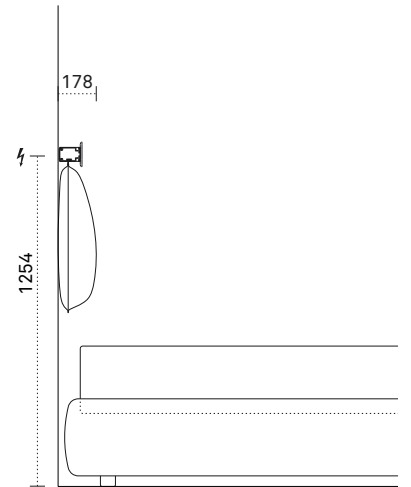
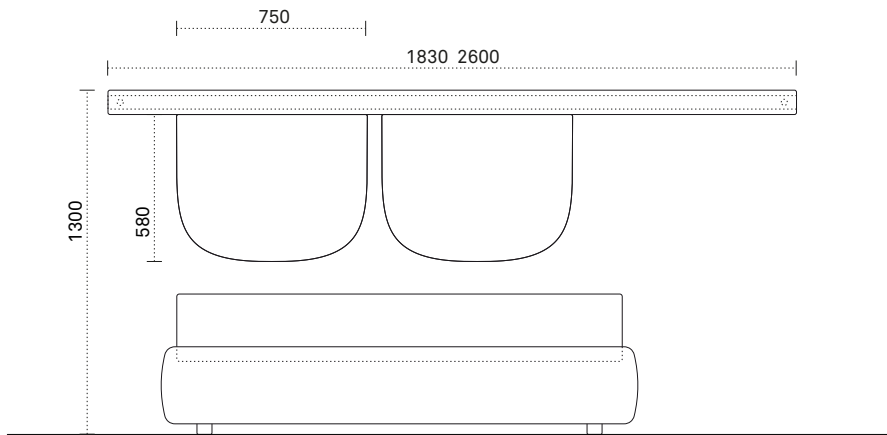

Illuminazione e impianto audio

Groove è disponibile con illuminazione led e impianto bluetooth regolabili con telecomando

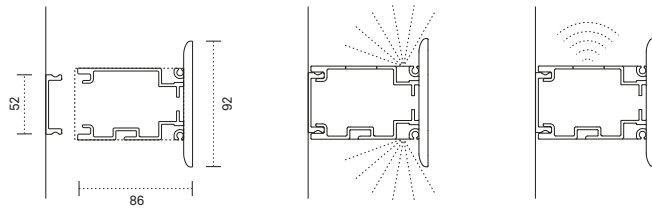

Giroletti abbinabili

Ring in alluminio laccato opaco o rivestito in tessuto

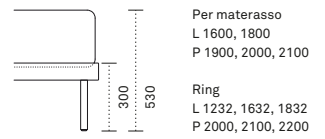

Box imbottito con o senza contenitore

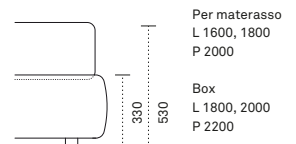





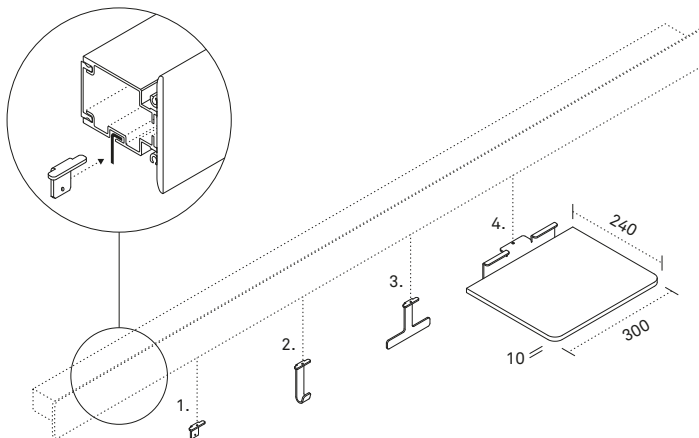





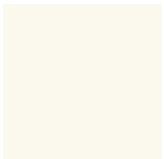



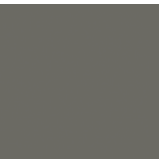
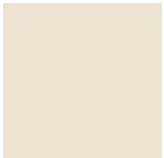

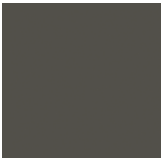
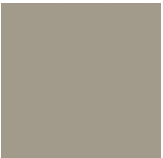

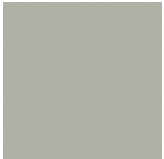
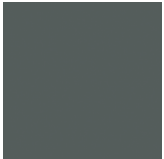

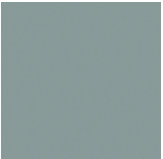

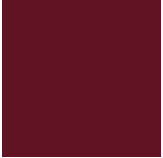
Accessori

1. Staffa Con Foro
2. Gancio
3. Appendino
4. Mensola

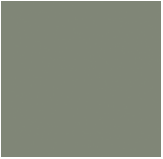

Materiali e finiture

Laccati

					
Bianconeve	Bianco 9010	Nero Stout	Rugiada	Fumo	Grafite
					
Gesso	Polvere	Ombra	Sabbia	Tundra	Pece
					
Cielo	Ardesia	Indaco	Salvia		
					
Cenere	Terra	Borgogna	Cotto	Amarone	
					
Sahara	Savana	Mattone	Quarzo	Scoglio	
			Possiamo lavorare anche su colore campione con riferimento scala RAL/NCS con opacità di serie.		
Laccato Opaco	Laccato Lucido Spazzolato		Possiamo lavorare anche su colore campione con riferimento scala RAL/NCS con opacità di serie.		

Finiture ad acqua



Dai primi anni duemila abbiamo scelto di utilizzare finiture all'acqua. Inodori e atossiche, abbattano il contenuto di solventi chimici: un contributo per ridurre il nostro impatto ambientale e tutelare la salute di dipendenti e clienti.

Pannelli CARB



Tutti i nostri pannelli aderiscono allo standard CARB 2. Un riferimento esigente, che si propone di ridurre al minimo le emissioni di formaldeide nel legno: i nostri pannelli ne contengono meno di 0,09 parti per milione.

Materiali e finiture

Tessuti



Barnum 10



Barkley 44



Lima 02



Boemian 20



Plain 00



Scott 02



Barnum 03



Barkley 04



Lima 03



Boemian 00



Plain 03



Scott 05



Barnum 14



Barkley 29

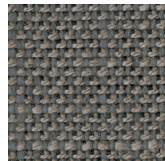

Lima 12

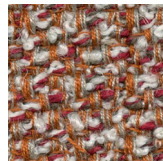

Boemian 80

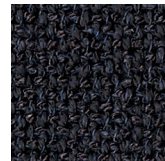

Plain 06



Scott 01



Barnum 13



Barkley 46

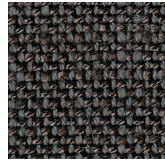

Lima 10



Boemian 30

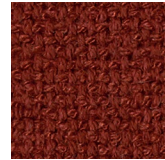

Plain 07



Barnum 23



Barkley 05

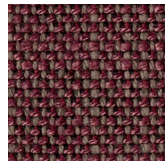

Lima 48



Boemian 70



Plain 02

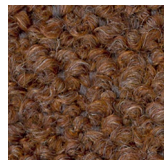

Barnum 21



Barnum 08



Barnum 07

Si assicura la migliore resa estetica con i tessuti da campionario Caccaro. A richiesta tessuto cliente. Tutti gli elementi in tessuto sono sfoderabili.