

# groove

prodotto

caccaro

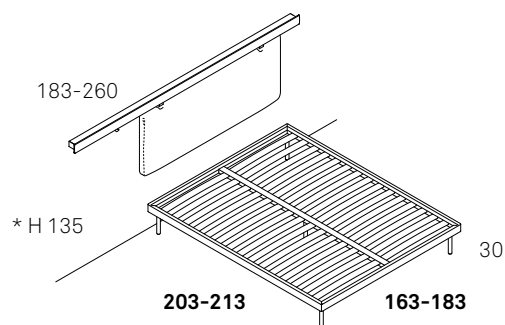
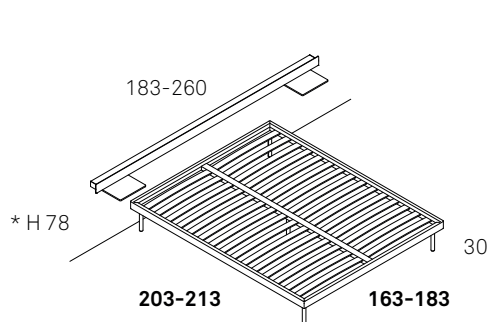
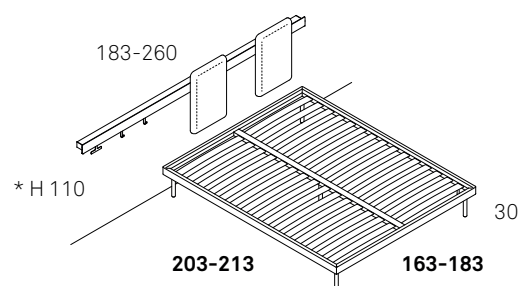

# groove

## finiture

laccato opaco

caccaro

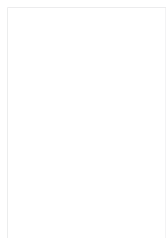

\* bianconeve

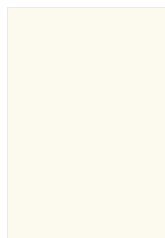

bianco 9010



nero stout



\* rugiada



fumo



grafite

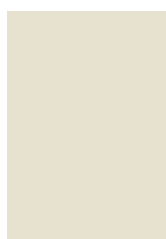

\* gesso



\* polvere



ombra

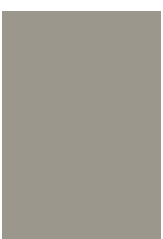

sabbia

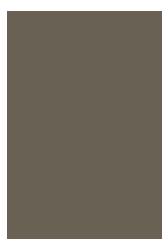

tundra



pece

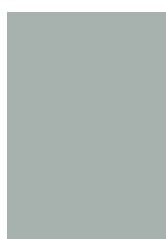

cielo



ardesia



indaco

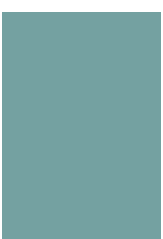

salvia



finiture all'acqua

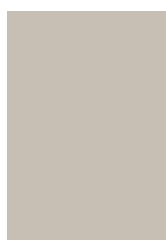

cenere



terra

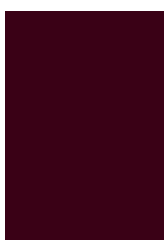

borgogna

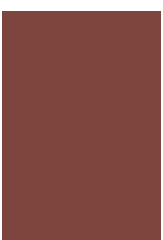

cotto



amarone

**colore campione**  
per tutte le finiture con  
opacità di serie



sahara

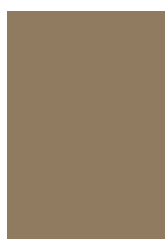

savana



mattone

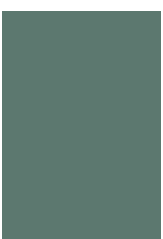

quarzo



scoglio



ral / ncs

letti / groove

Per specifiche contatta il rivenditore

# groove

caccaro

## tessuti

### SCOTT



01



02



04



03

COMPOSIZIONE 56% CO - 30% VI - 14% LI



### STEP



01



02



04



05



03

COMPOSIZIONE 58% CO - 27% VI - 15% LI



### PLAIN



01



02

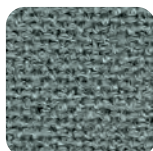

03

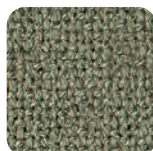

04



05



06

COMPOSIZIONE 54% CO - 30% VI - 16% LI



### FELT



01

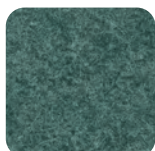

02



03



04



05

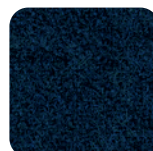

07



06

COMPOSIZIONE 70% WO - 25% PA - 5% AF

